

Varenummer: 20992V20M8

Beskrivelse: E+G Gevind indsats - GN 992-V20-M8

Mål

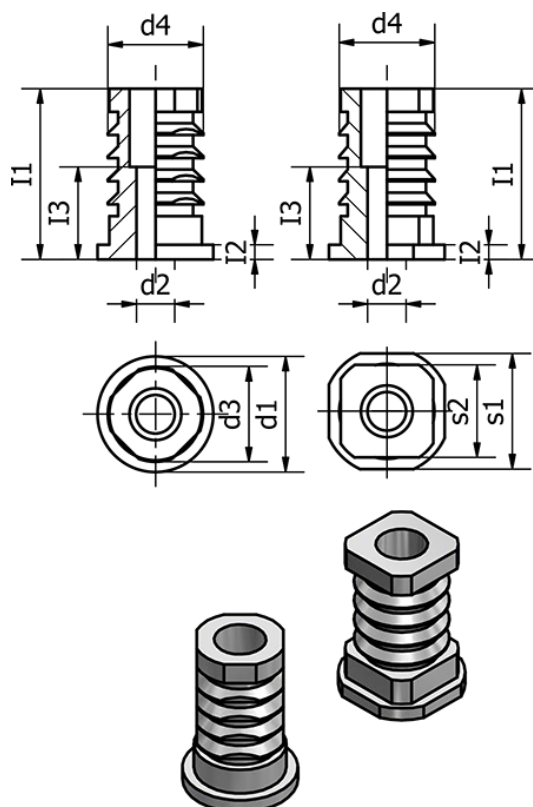

d1 =	s2 = 16
d2 = 8	Vægt (g) = 11
d3 =	
d4 = 16.5	
I1 = 29.5	
I2 = 2.5	
I3 = 16	
s1 = V20	